

SNOOP 2 WALL MOUNT UP DOWN

INDOOR WALL MOUNTED
LUMINAIRE



- Compatible with 20 Series LED modules
- Colour temperature options: 2700K, 3000K, 3500K, 4000K, 5000K, tuneWHITE™, WARM DIM, flexiK
- Colour rendering index: 85 or 95
- Up to 50,000 hours L80 lamp life with LM80 tested LED chip packages
- Beam pattern options: 15°, 30°
- Luminous flux: 410lm to 565lm (depending on LED module)
- Supplied with non-dimmable or phase/0-10V/DALI dimmable LED driver
- IP20
- 42mm diameter x 190mm height
- ATePS™ Automated Thermal Protection System
- ComfyEYE, reduced flicker percentage
- Interchangeable LED module system
- Optional linear spread lens, colour, light effect filters and honeycomb anti-glare louvre
- Top and bottom with the same reflector design



FIXTURE COLOUR OPTIONS



REFLECTOR COLOUR OPTIONS

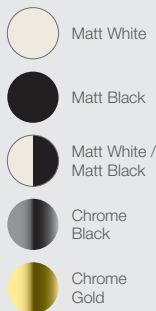

tuneWHITE™ and flexiK are recommended to pair with Soft Lens for better colour mixing effect.

AVAILABLE OPTIONS

LED MODULE



TEMPERATURE



DRIVER



ACCESSORIES

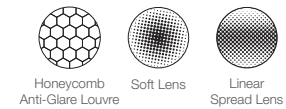

BEAM ANGLE

SINGLE CCT
20 CLASSIC / 20 PRO

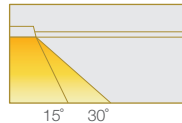

WARM DIM / tuneWHITE™ / flexiK
20 PRO

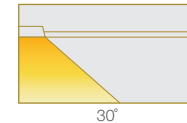

DIMENSIONS (MM)

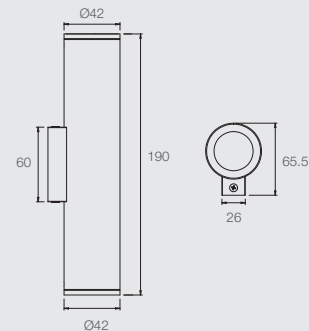

*Displayed height measurements are for highest point of tilting.

SNOOP 2 WALL MOUNT

20 PRO

POLAR DIAGRAM

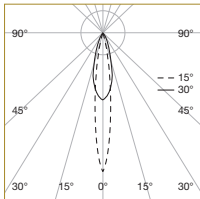

CONE DIAGRAM

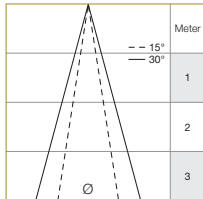

	E _{max} (lx)	
	15°	30°
E (0°)	4093	1951
Cone DØ (m)	0.29	0.52
E (0°)	1023	488
Cone DØ (m)	0.58	1.05
E (0°)	455	217
Cone DØ (m)	0.88	1.57

Ø = DIAMETER

Correction Factor : 20C - f = 0.73

20 PRO WARM DIM

POLAR DIAGRAM

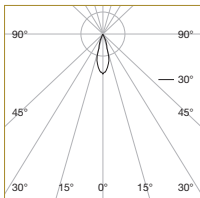

CONE DIAGRAM

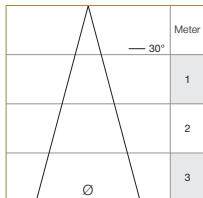

	E _{max} (lx)	
	30°	
E (0°)	972	
Cone DØ (m)	0.54	
E (0°)	243	
Cone DØ (m)	1.08	
E (0°)	108	
Cone DØ (m)	1.62	

Ø = DIAMETER

20 PRO tuneWHITE™ / flexik

POLAR DIAGRAM

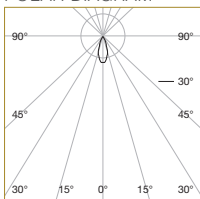

CONE DIAGRAM

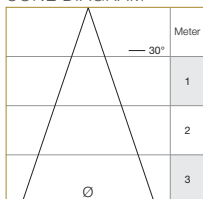

	E _{max} (lx)	
	30°	
E (0°)	728	
Cone DØ (m)	0.68	
E (0°)	182	
Cone DØ (m)	1.37	
E (0°)	81	
Cone DØ (m)	2.05	

Ø = DIAMETER

SNOOP 2 WALL MOUNT

ORDERING MATRIX CHART

FIXTURE					SINGLE CCT LED MODULE				DRIVER
Type	Shape	Colour	Reflector Color	Accessories	LED Power	Beam Angle	Colour Temp	CRI	Dimming
SNOOP-2WM									
D	Down	WH Matt White	WH Matt White	AGL Anti-Glare Louvre	20C 4.5W	15 15°	27 2700K	Standard	ND Non-Dim
UD	Up/down	MB Matt Black	MB Matt Black	SL Soft Lens	20P 6.2W	30 30°	30 3000K	PA ProART	PH Phase
			WB White/Black	LSL Linear Spread Lens			35 3500K		AN 0-10V
			CB Chrome Black	LBA Local Brightness Adjuster			40 4000K		DA DALI
			CG Chrome Gold				50 5000K		
WARM DIM LED MODULE									DRIVER
					20P 6.2W	30 30°	WD WARM DIM	PA ProART	PH Phase
									AN 0-10V
									DA DALI
tuneWHITE™ LED MODULE									DRIVER
					20P 6.2W	30 30°	TW18 tuneWHITE™ 1800K-4000K	PA ProART	DA DALI
							TW27 tuneWHITE™ 2700K-6500K		
flexiK LED MODULE									DRIVER
					20P 6.2W	30 30°	FK## flexiK	PA ProART	PH Phase
									AN 0-10V
									DA DALI

example: SNOOP-2WM.D.WH.WH.AGL.20P.15.30.PH
 *Custom RAL colour options available.

denotes the first two digits of preferred CCT ranging from 1800K to 6500K by increment of 100K